

REV	DESCRIPTION	ECN NO	DATE

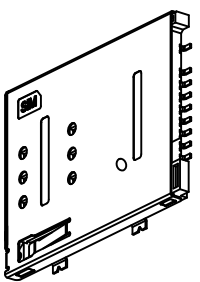
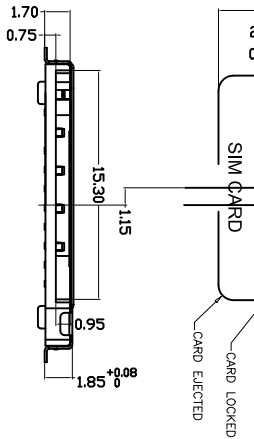
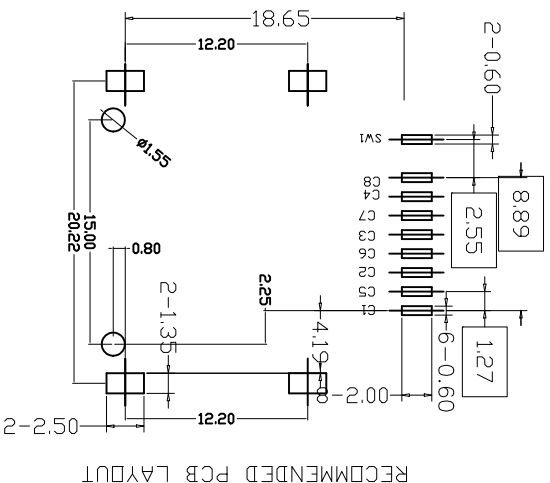
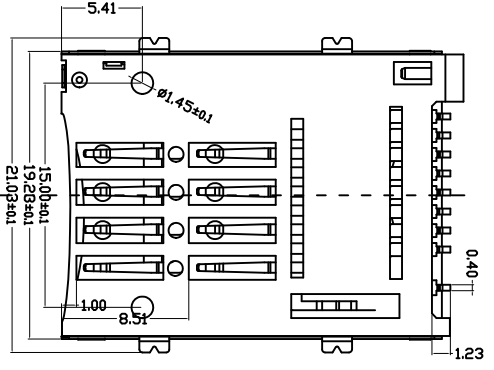
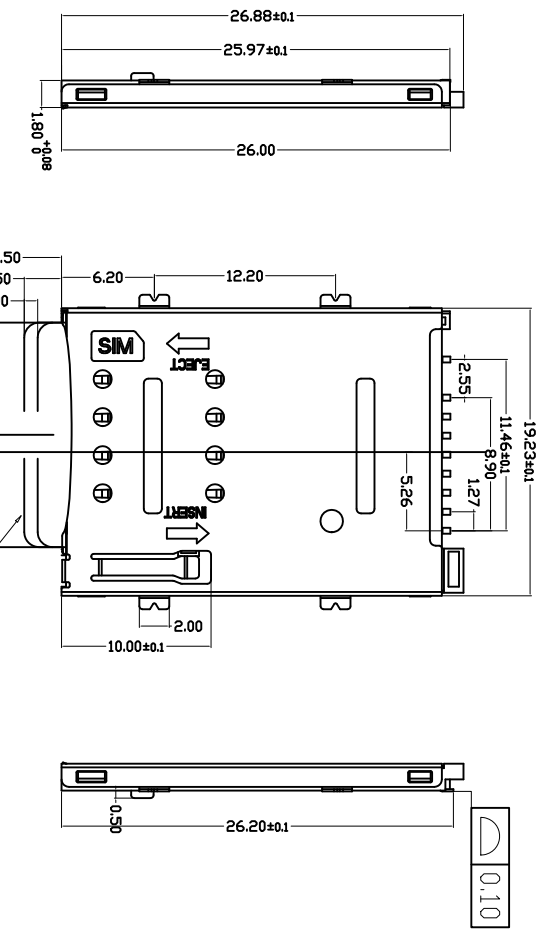

- SPECIFICATIONS:  
INSULATION RESISTANCE: 500M min. AT DC, 500V, DC  
WITHSTANDING VOLTAGE: 230V AC rms FOR 1 MINUTE  
CONTACT RESISTANCE: 100M max. AT 10mA/20mV max  
CURRENT RATING: 0.5A  
VOLTAGE RATING: 5.0 Vrms  
OPERATING TEMP RANGE: -55 C+85 C  
MATING CYCLES: 5000 INSERTIONS
- MATERIAL:  
INSULATOR: H-TEMPERATURE PLASTIC, UL 94V-0,  
COLOR: BLACK  
TERMINAL: COPPER ALLOY, T=0.15mm  
SHELL: STAINLESS STEEL, T=0.15mm
- FINISH:  
TERMINAL: 50u" min NICKEL UNDERPLATED ON ALLOYER, GOLD PLATING  
ON CONTACT AREA, 80u" min TIN ON SOLDER TAIL.  
SHELL: 50u" NICKEL UNDERPLATED ON ALLOYER, GOLD FLASH ON SOLDER LATCH

SIM pin assignment

PIN#	Name
C1	VCC
C2	RST
C3	CLK
C4	Reserved
C5	GND
C6	VPP
C7	I/O
C8	Reserved

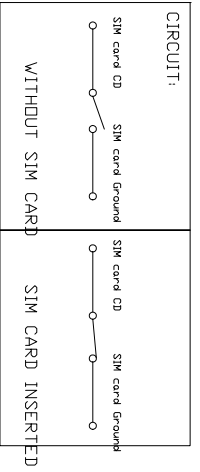

GENERAL TOLERANCES (UNLESS SPECIFIED)		DIMENSION STYLE MM ONLY	
XX	±0.25	DRAWN BY: Frank	DATE 11-7-9
XXX	±0.15	CHECKED BY:	DATE
XXXX	±0.05	APPRIAL BY:	DATE

JIXING TECHNOLOGY CO., LTD		TITLE: SIM Card Push 8+1Pin 贴片式 带柱
		PART NO: SIM-007-Z
SIZE: A4	SCALE: ---	SHEET NO: 1 OF 1

REV	DESCRIPTION	ECN NO	DATE

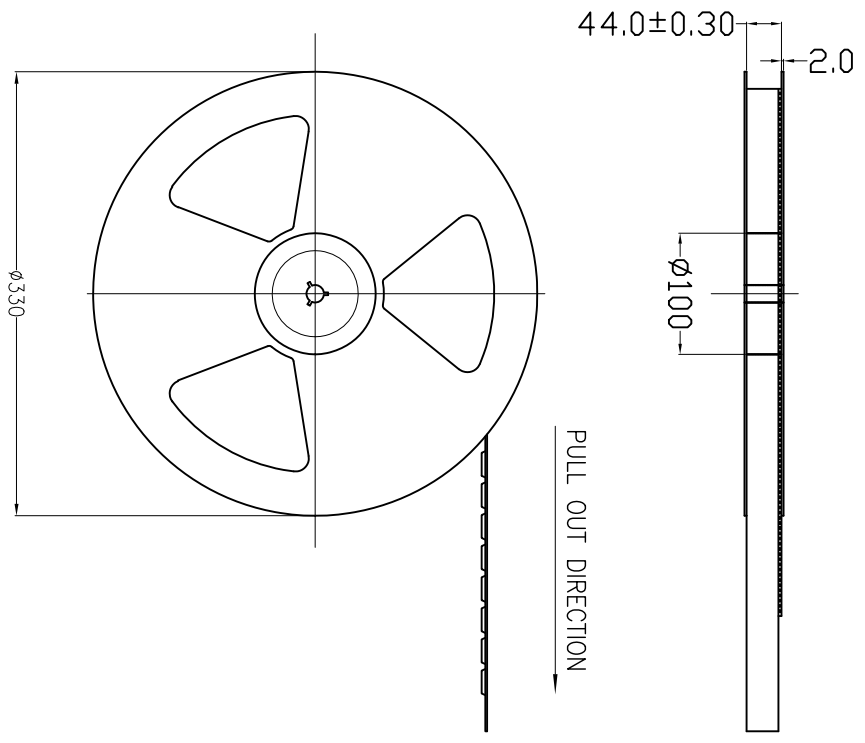
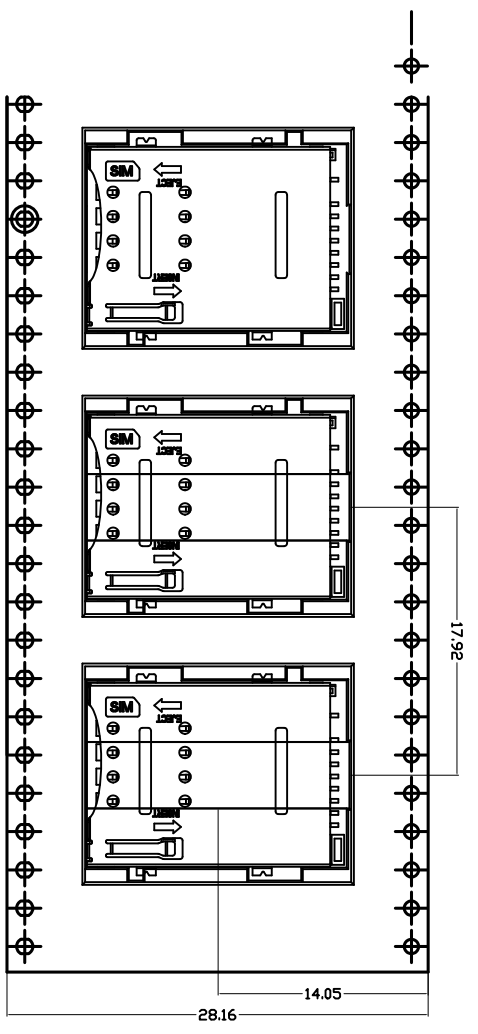

- Note:
- 1.10 sprocket hole pitch cumulative tolerance  $\pm 0.2$
  - 2.Carrier camber is within 1 mm in 250mm.
  - 3.Material:Black Conductive Polystyrene Alloy 100% recyclable.
  - 4.All dimensions meet EIA-481-B requirements.
  - 5.Thickness: $0.3\pm 0.05$ mm.
  - 6.Component load per 13" reel:800 pcs.
  7. A box of 5 volumes, 4000PCS
  8. 纸箱规格: 345\*345\*315, 纸箱重为300g
  9. 重量: 每盘800PCS重1670g, 每Pcs重1.3g/Pcs

GENERAL TOLERANCES (UNLESS SPECIFIED)		DIMENSION STYLE MM ONLY		TITLE:	
XX	$\pm 0.25$	DRAWN BY:	DATE	SIM Card Push 8+1Pin 贴片式 带柱	
X.XX	$\pm 0.15$	Checked BY:	DATE	PART NO:	
X.XXX	$\pm 0.05$	APPERIAL BY:	DATE	SIM-007-Z	

**JIXING TECHNOLOGY CO.,LTD**

GENERAL TOLERANCES (UNLESS SPECIFIED)		DIMENSION STYLE MM ONLY		TITLE:	
XX	$\pm 0.25$	DRAWN BY:	DATE	SIM Card Push 8+1Pin 贴片式 带柱	
X.XX	$\pm 0.15$	Checked BY:	DATE	PART NO:	
X.XXX	$\pm 0.05$	APPERIAL BY:	DATE	SIM-007-Z	

**JIXING TECHNOLOGY CO.,LTD**